

KombiSIGN 71 / Terminal Element

USB-Terminal element RM 5VDC BK



Part No.:	640.840.00
Series:	KombiSIGN 71



MECHANICAL DATA

Length	70 mm
Width	70 mm
Height	41 mm
Diameter	70 mm
Materials	PA-GF
Housing colour	Black
Protection category	IP65
Connection	USB
Cable entry	Through hole
Cable entry maximum	d = 14 mm
Type of fixing	Tube mounting
Service life optical	50,000 h maximum
Working temperature minimum	-20°C
Working temperature maximum	+50°C
Weight with packaging	211 g
Product weight	170 g

ELECTRICAL DATA

Operating voltage	5V (USB)
Operating voltage type	DC
Operating voltage tolerance	+/- 0%
Rated operational voltage	5 VDC
Rated operational current	500 mA
Protection class	Protection class 2
Pollution degree	3
Request to external PSU	SELV/PELV



For additional installation and mounting information, refer to the appropriate user guide at www.werma.com. This printed copy is for information only and is subject to alteration.

KombiSIGN 71 / Terminal Element

USB-Terminal element RM 5VDC BK

DRAWING

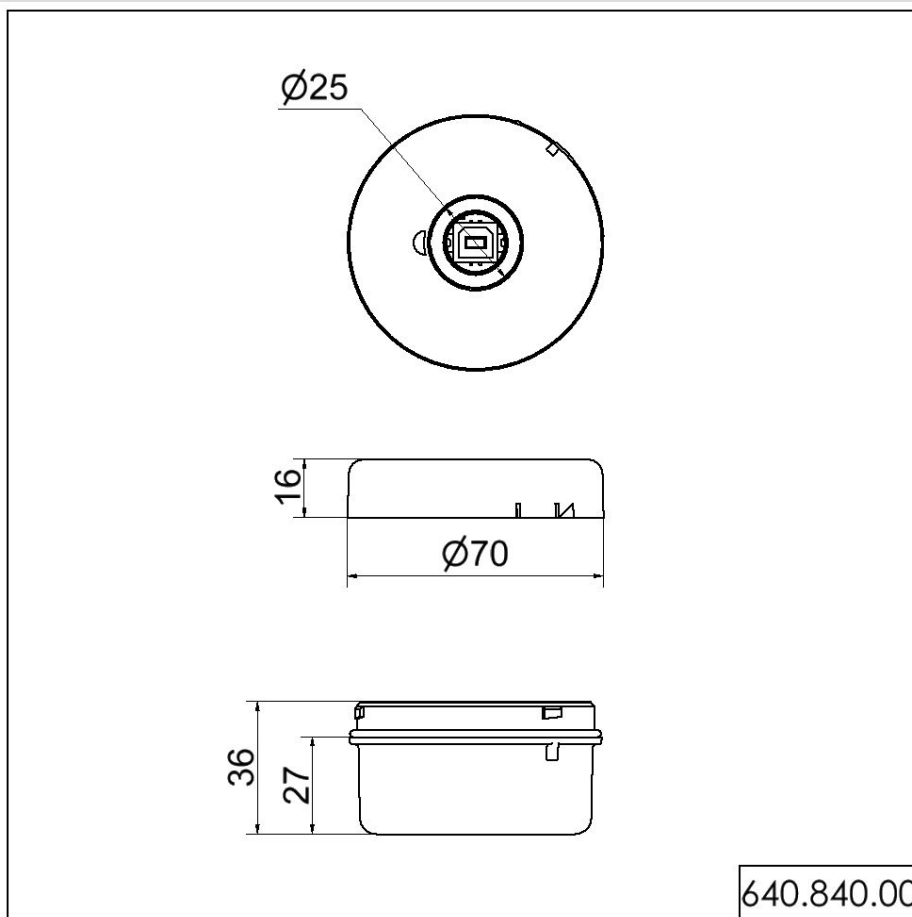

For additional installation and mounting information, refer to the appropriate user guide at www.werma.com. This printed copy is for information only and is subject to alteration.