

WERMA Signaltechnik GmbH + Co.KG
D-78604 Rietheim-Weiheim
Telefon + 49 (0) 7424/9557-0
Telefax + 49 (0) 7424/9557-44
info@werma.com
www.werma.com

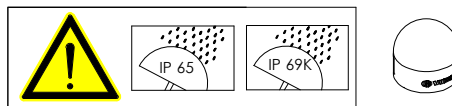

- Ⓓ Anschluss ausschließlich durch ausgebildete Elektro-Fachkräfte.
- ⒸⒺ Electrical connection is to be made by trained electrical specialists only .
- Ⓕ Le branchement doit uniquement être effectué par des professionnels.
- Ⓖ Il collegamento deve essere eseguito solo da elettricisti specializzati.
- Ⓔ La conexión sólo debe ser realizada por electricistas debidamente formados.
- Ⓗ A ligação deve ser feita exclusivamente por profissional elétrico especializado.
- Ⓖ De aansluiting mag enkel gebeuren door erkende vakmensen.
- ⒸⒹ Pripojení smí provádět pouze kvalifikovaný personál.
- Ⓖ Podłączenie wyłącznie przez specjalistów-elektryków.
- Ⓖ Liittäminen kuuluu ainoastaan koulutettujen sähköalan ammattilaisten tehtäviin.
- Ⓖ Подключёние проводов только специалистом-электриком.
- Ⓖ Bağlantı sadece eğitimli elektrik teknisyenleri tarafından yapılmalıdır.
- Ⓖ 布线需由专业电工执行

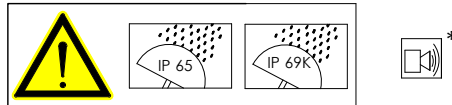
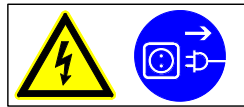

241 320 50	The power-source has to be an isolated secondary source limited by maximum 0.5A and maximum 32 VDC
241 340 50	
241 420 55	
241 440 55	



LED Permanent RGB M12 UL	241 320 50	10-30V=	I ≤70 mA I ₀ <900 mA I ₂₀ <45 mA
LED Permanent RGB M12 UL	241 340 50	10-30V=	
LED Permanent RGY Cable	241 210 55	24V=	I ≤15 mA I ₀ ≤15 mA
LED Permanent RGY M12	241 220 55	24V=	
LED Permanent RGY M12 UL	241 420 55	24V=	I ≤35 mA I ₀ <600 mA
LED Permanent RGY M12	241 240 55	24V=	
LED Permanent RGY Cable	241 230 55	24V=	I ≤35 mA I ₀ <600 mA
LED Permanent RGY M12 UL	241 440 55	24V=	

241 210 55, 241 230 55 241 220 55, 241 240 55

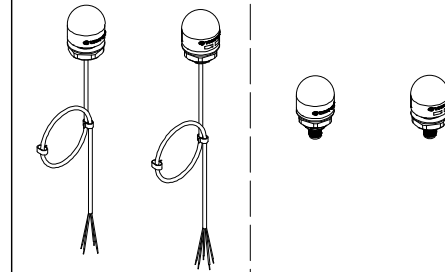

Cable length:
145cm/57.09"

Plastic M12 Connector

241 320 50, 241 340 50
241 420 55, 241 440 55



Metal M12 Connector

Model number	Limited voltage [VDC]	Limited current [mA]
241 320 50	10-30	60
241 340 50	10-30	70
241 420 55	24	15
241 440 55	24	35

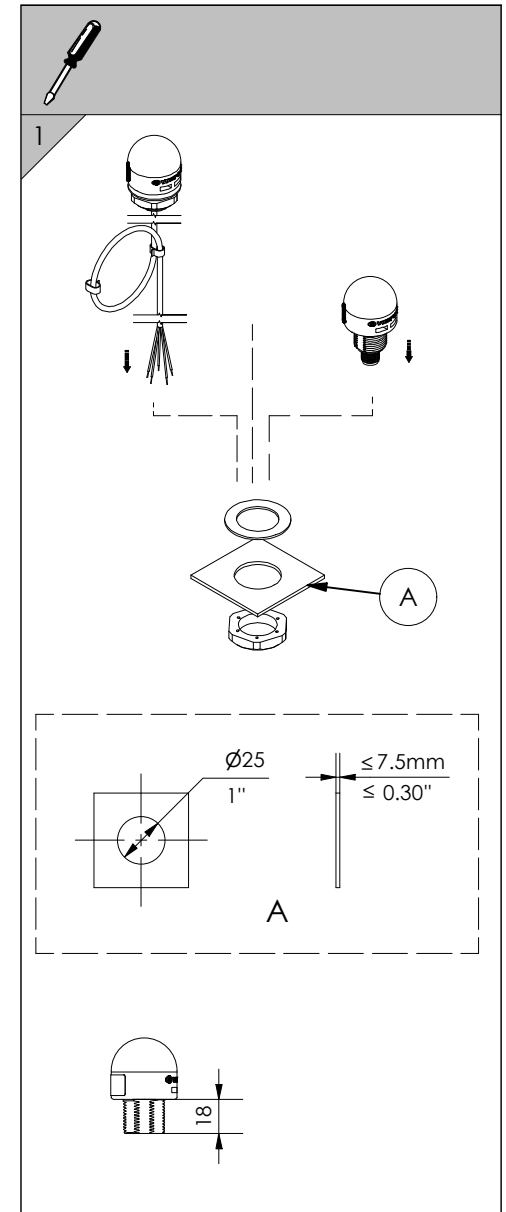

2
 2a - 241 210 55 241 230 55
 2b - 241 220 55 241 240 55
 241 420 55 241 440 55
 2c - 241 320 50 241 340 50,

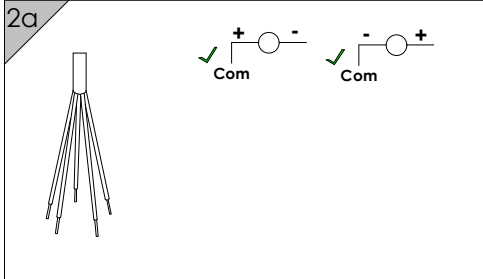

Wire					Colour
WH	RD	GN	YE	GY*	
(±) Com	(±) V	NC	NC	(±) V	RD
	NC	(±) V	NC		GN
	NC	NC	(±) V		YE

NC = not connected

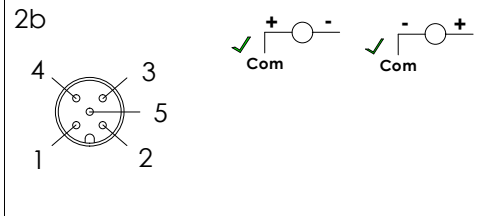

Pin					Colour
1	2	3	4	5 *	
NC	NC	(±) Com	(±) V	(±) V	RD
(±) V	NC		NC		
NC	(±) V		NC		YE

NC = not connected

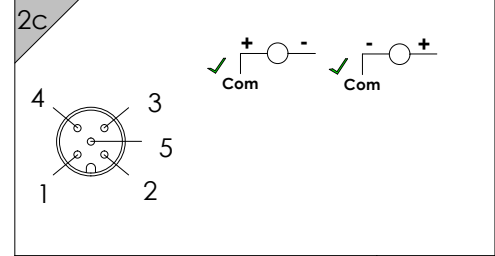

Pin					Colour
1	2	3	4	5 *	
NC	NC	(±) Com	(±) V	(±) V	RD
(±) V	NC		NC		
(±) V	NC		(±) V		YE
NC	(±) V		NC		BU
(±) V	(±) V		(±) V		WH
NC	(±) V		(±) V		VT
(±) V	(±) V		NC		TQ

NC = not connected



Marking of Hazardous Substances
有害物质标识

WERMA Signaltechnik GmbH + Co. KG
 Dürbheimer Straße 15
 78604 Rielheim-Welheim / Germany

WERMA article number 伟马连接器料号:
 241 210 55, 241 220 55, 241 420 55, 241 320 50

According to the SJ/T 11364-2014 Standard of the People's Republic of China for the Electronic Industry
 本标准按照中华人民共和国 SJ/T 11364-2014 的规定编制

Component Name 部件名称	Hazardous Substances 有害物质				
	Lead 铅(Pb)	Mercury 汞(Hg)	Cadmium 镉(Cd)	Hexavalent Chromium 六价铬(Cr(VI))	Polybrominated diphenyl ethers 多溴联苯醚(PBDE)
Plastic parts 塑料件	0	0	0	0	0
Label 标签	0	0	0	0	0
PCB and its electronics components 印制电路板及其电子元器件	X*	0	0	0	0
M12 plug and cable M12 插头和电缆	0	0	0	0	0
Cable tie 扎带	0	0	0	0	0

This table was developed according to the provisions of SJ/T 11364-2014
 本表格按照 SJ/T 11364-2014 的规定编制
 O: The content of such hazardous substance in all homogeneous materials of such component is below the limit required by GB/T 26572-2011.
 表示该有害物质在该部件所有均质材料中的含量均在 GB/T 26572-2011 规定的限量要求以下。
 X: The content of such hazardous substance in all homogeneous materials of such component is beyond the limit required by GB/T 26572-2011.
 表示该有害物质在该部件的某一均质材料中的含量超出 GB/T 26572-2011 规定的限量要求。
 Enterprises may further explain the technical reasons for ticking "X" in the table above according to their actual situation herein.
 企业可在此处，根据实际情况对上表中打“X”的技术原因进行进一步说明。
 *Exemptions according to EU RoHS 2011/65 Annex III and IV might be applied
 *根据 RoHS 2011/65 附件 III 和 IV 的豁免可能适用
 ■ Restricted substances beyond limit required by GB/T 26572-2011
 限制物质的含量超过 GB/T 26572-2011 规定的限制
 EUP (Environment Friendly Use Period) 环保使用期限:

Kenny
 i.v. 授权 D. Kerfny
 Director R&D 研发总监

Rielheim 里睿姆 13.09.2022
 Place and date of issue 签发地点和日期



Marking of Hazardous Substances
有害物质标识

WERMA Signaltechnik GmbH + Co. KG
 Dürbheimer Straße 15
 78604 Rielheim-Welheim / Germany

WERMA article number 伟马连接器料号:
 241 230 55, 241 240 55, 241 440 55, 241 340 50

According to the SJ/T 11364-2014 Standard of the People's Republic of China for the Electronic Industry
 本标准按照中华人民共和国 SJ/T 11364-2014 的规定编制

Component Name 部件名称	Hazardous Substances 有害物质				
	Lead 铅(Pb)	Mercury 汞(Hg)	Cadmium 镉(Cd)	Hexavalent Chromium 六价铬(Cr(VI))	Polybrominated diphenyl ethers 多溴联苯醚(PBDE)
Plastic parts 塑料件	0	0	0	0	0
Label 标签	0	0	0	0	0
PCB and its elect. comp. 印制电路板及其电子元器件	X*	0	0	0	0
Buzzer 蜂鸣器	X*	0	0	0	0
M12 plug and cable M12 插头和电缆	0	0	0	0	0
Cable tie 扎带	0	0	0	0	0

This table was developed according to the provisions of SJ/T 11364-2014
 本表格按照 SJ/T 11364-2014 的规定编制
 O: The content of such hazardous substance in all homogeneous materials of such component is below the limit required by GB/T 26572-2011.
 表示该有害物质在该部件所有均质材料中的含量均在 GB/T 26572-2011 规定的限量要求以下。
 X: The content of such hazardous substance in all homogeneous materials of such component is beyond the limit required by GB/T 26572-2011.
 表示该有害物质在该部件的某一均质材料中的含量超出 GB/T 26572-2011 规定的限量要求。
 Enterprises may further explain the technical reasons for ticking "X" in the table above according to their actual situation herein.
 企业可在此处，根据实际情况对上表中打“X”的技术原因进行进一步说明。
 *Exemptions according to EU RoHS 2011/65 Annex III and IV might be applied
 *根据 RoHS 2011/65 附件 III 和 IV 的豁免可能适用
 ■ Restricted substances beyond limit required by GB/T 26572-2011
 限制物质的含量超过 GB/T 26572-2011 规定的限制
 EUP (Environment Friendly Use Period) 环保使用期限:

Kenny
 i.v. 授权 D. Kerfny
 Director R&D 研发总监

Rielheim 里睿姆 13.09.2022
 Place and date of issue 签发地点和日期

