

Midi free-standing Beacons / LED Permanent-/ Blink-/ Revolving Light 829

LED Perm. Beacon BM 230VAC BU



Part No.: 829.530.68



MECHANICAL DATA	
Height	137 mm
Diameter	98 mm
Materials	PC PC/ABS
Dome colour	Blue
Housing colour	Black
Protection category	IP65
Connection	Screw terminals
cross-sectional area minimum	0,50mm ² / 20AWG
cross-sectional area maximum	1,50mm ² / 16AWG
Cable entry	Rubber pinch
Cable entry minimum	d = 5 mm
Cable entry maximum	d = 7 mm
Type of fixing	Base mounting
Service life optical	50,000 h maximum
Working temperature minimum	-20°C
Working temperature maximum	+50°C
UL Type Rating	Type 12
Weight with packaging	251 g
Product weight	208 g
ELECTRICAL DATA	
Operating voltage	230V
Operating voltage type	AC
Operating voltage type	50Hz
Operating voltage tolerance	+/- 10%
Rated operational voltage	230 VAC
Rated operational current	30 mA
Rated inrush current	500 mA
Protection class	Protection class 2
Pollution degree	3
Overvoltage category	II
Isolation voltage	Ui = 250V; Uimp = 2.500V
OPTICAL DATA	
Light source	LED
Light colour	Blue
Optical signal image	Permanent

! For additional installation and mounting information, refer to the appropriate user guide at www.werma.com. This printed copy is for information only and is subject to alteration.

Midi free-standing Beacons / LED Permanent-/ Blink-/ Revolving Light 829
LED Perm. Beacon BM 230VAC BU

DRAWING

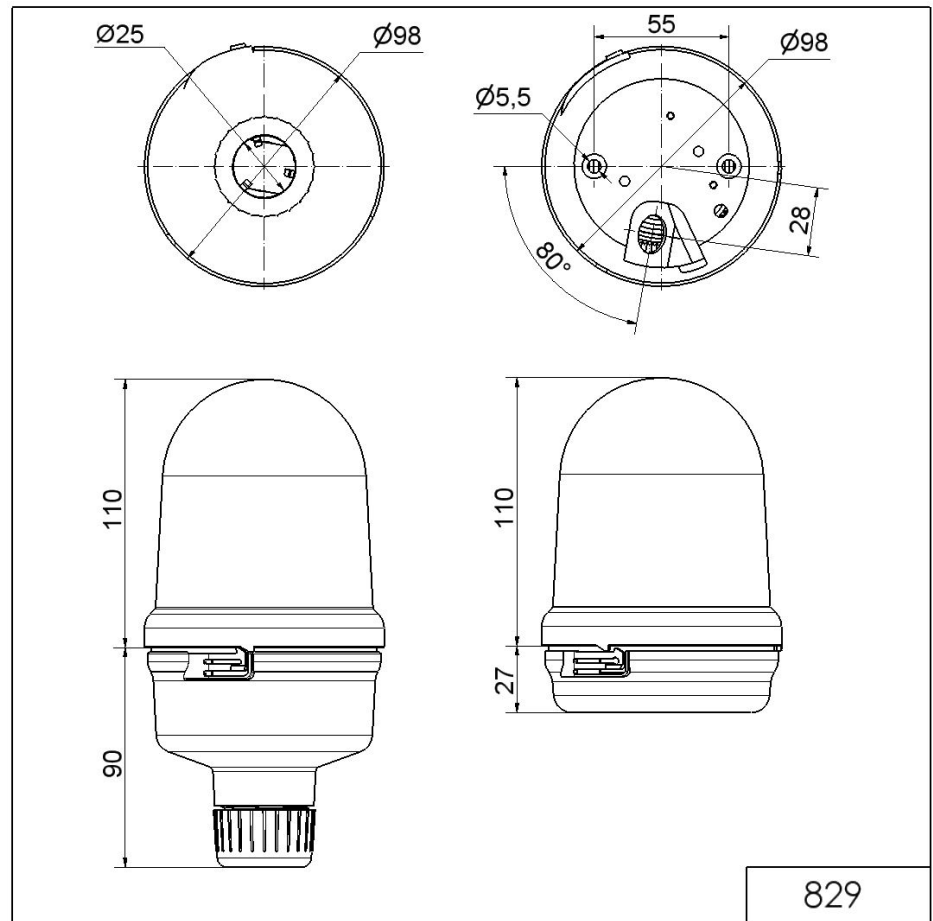

! For additional installation and mounting information, refer to the appropriate user guide at www.werma.com. This printed copy is for information only and is subject to alteration.