

Midi free-standing Beacons / Flash Light 828

Flashing Beacon BM 24VDC RD

Part No.: 828.100.55

**MECHANICAL DATA**

Height	137 mm
Diameter	98 mm
Materials	PC PC/ABS
Dome colour	Red
Housing colour	Black
Protection category	IP65
Connection	Screw terminals
cross-sectional area maximum	2,50mm ² / 14AWG
Cable entry	Rubber pinch
Cable entry minimum	d = 5 mm
Cable entry maximum	d = 7 mm
Type of fixing	Base mounting
Service life optical	4 million flashes minimum
Working temperature minimum	-20°C
Working temperature maximum	+45°C
UL Type Rating	Type 12
Weight with packaging	280 g
Product weight	220 g

ELECTRICAL DATA

Operating voltage	24V
Operating voltage type	DC
Operating voltage tolerance	+/- 10%
Rated operational voltage	24 VDC
Rated operational current	300 mA
Rated inrush current	12.000 mA
Protection class	Protection class 2
Pollution degree	3

OPTICAL DATA

Light source	Xenon
Light colour	Red
Optical signal image	Flash
Flash frequency	1 Hz
Flash output	5 J



For additional installation and mounting information, refer to the appropriate user guide at www.werma.com. This printed copy is for information only and is subject to alteration.

Midi free-standing Beacons / Flash Light 828
Flashing Beacon BM 24VDC RD

DRAWING

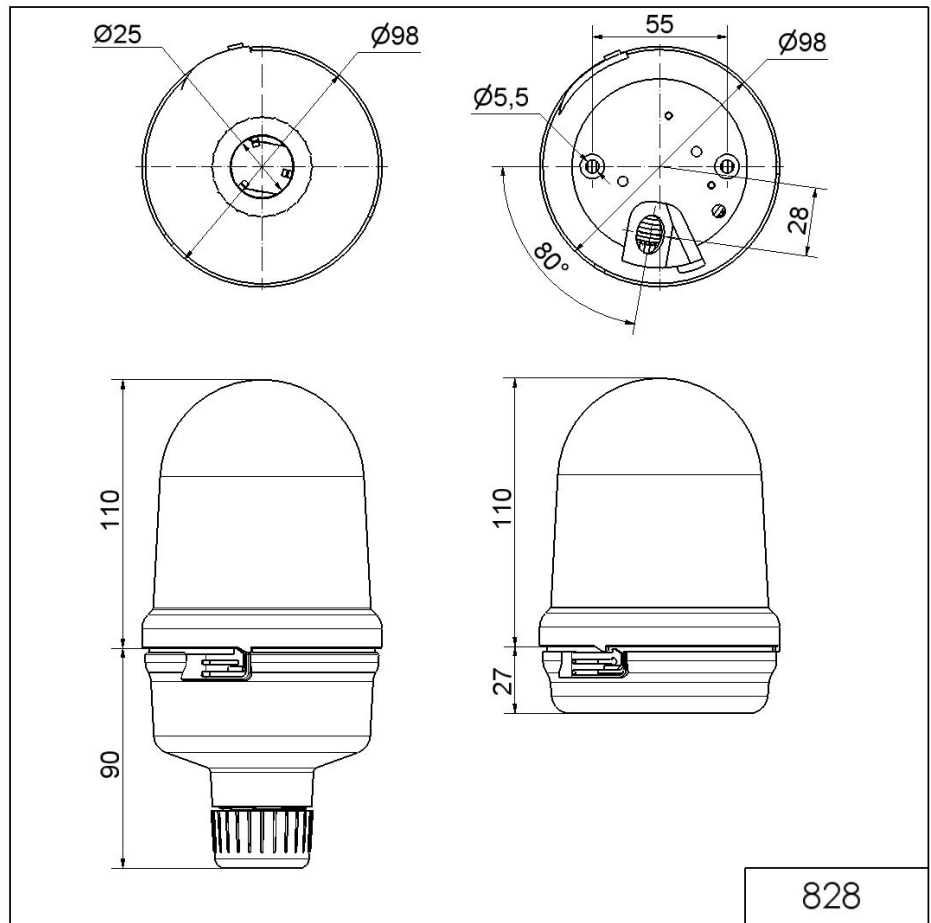

! For additional installation and mounting information, refer to the appropriate user guide at www.werma.com. This printed copy is for information only and is subject to alteration.