

Mini free-standing Beacons / LED-Permanent Light 214

LED Perm. Beacon WM 24VAC/DC YE

Part No.: 214.300.75



MECHANICAL DATA	
Height	123 mm
Diameter	58 mm
Materials	PA-GF PC
Dome colour	Yellow
Housing colour	Black
Protection category	IP65
Connection	Spring-type terminal
cross-sectional area maximum	2,50mm ² / 14AWG
Cable entry	Screwed cable gland
Cable entry minimum	d = 3 mm
Cable entry maximum	d = 6 mm
Tension relief	Present (conforms to VDI)
Type of fixing	Wall mounting
Service life optical	100,000 h maximum
Working temperature minimum	-20°C
Working temperature maximum	+50°C
UL Type Rating	Type 12
Weight with packaging	104 g
Product weight	74 g
ELECTRICAL DATA	
Operating voltage	24V
Operating voltage type	AC/DC
Operating voltage type	50Hz
Operating voltage tolerance	+/- 10%
Rated operational voltage	24 VDC
Rated operational current	45 mA
Rated inrush current	500 mA
Protection class	Protection class 2
Pollution degree	3
OPTICAL DATA	
Light source	LED
Light colour	Yellow
Optical signal image	Permanent



For additional installation and mounting information, refer to the appropriate user guide at www.werma.com. This printed copy is for information only and is subject to alteration.

Mini free-standing Beacons / LED-Permanent Light 214
LED Perm. Beacon WM 24VAC/DC YE

DRAWING

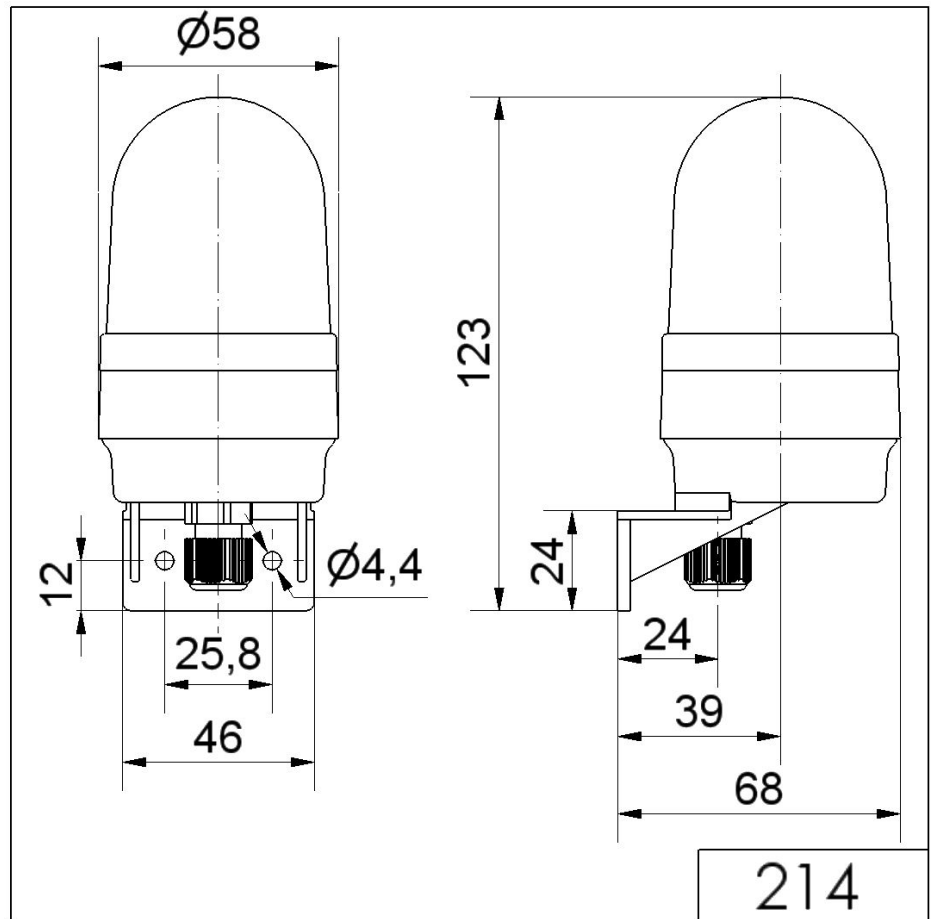

For additional installation and mounting information, refer to the appropriate user guide at www.werma.com. This printed copy is for information only and is subject to alteration.